

**96401837 UPS 32-120 F 50 Hz**

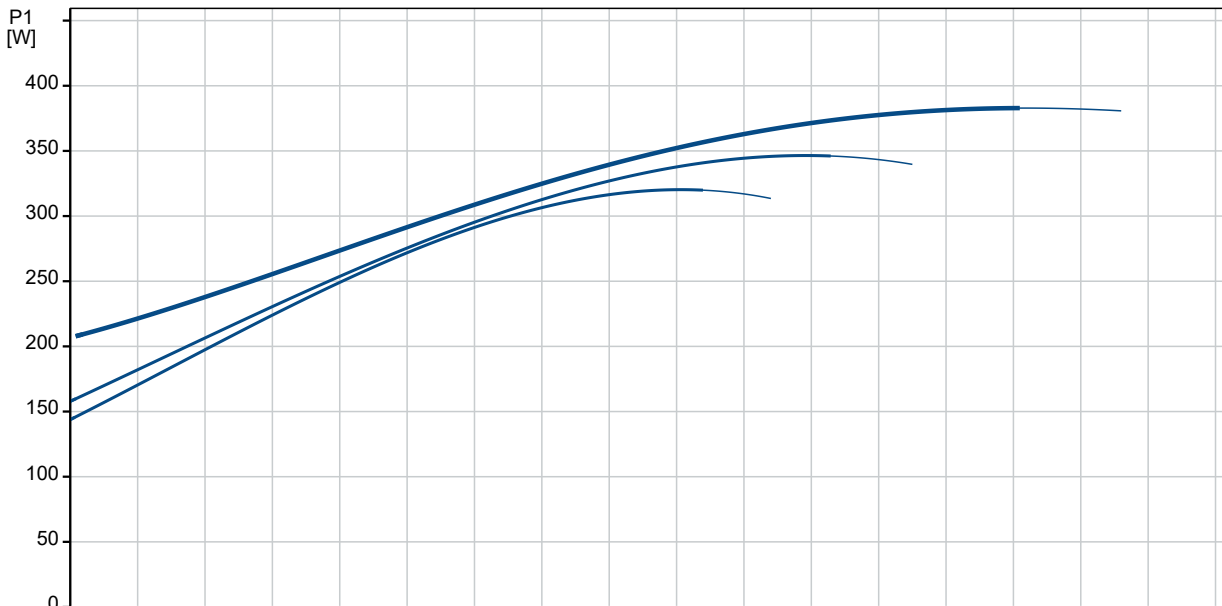

Description	Value
<b>General information:</b>	
Product name:	UPS 32-120 F
Product No:	96401837
EAN number:	5700390905071
Price:	
<b>Technical:</b>	
Speed no:	3
Head max:	120 dm
Approvals on nameplate:	AAA,EAC
<b>Materials:</b>	
Pump housing:	Cast iron
Pump housing:	EN-JL1040
Pump housing:	ASTM 35 B - 40 B
Impeller:	Stainless steel
Impeller:	DIN W.-Nr. 1.4301
Impeller:	AISI 304
<b>Installation:</b>	
Range of ambient temperature:	0 .. 40 °C
Maximum operating pressure:	10 bar
Flange standard:	DIN
Pipe connection:	DN 32
Pressure rating:	PN 6 / PN 10
Port-to-port length:	220 mm
<b>Liquid:</b>	
Pumped liquid:	Water
Liquid temperature range:	-10 .. 120 °C
Selected liquid temperature:	60 °C
Density:	983.2 kg/m <sup>3</sup>
<b>Electrical data:</b>	
Power input in speed 1:	320 W
Power input in speed 2:	340 W
Max. power input:	380 W
Mains frequency:	50 Hz
Rated voltage:	1 x 230-240 V
Current in speed 1:	1.55 A
Current in speed 2:	1.65 A
Current in speed 3:	1.75 A
Cos phi in speed 1:	0.9
Cos phi in speed 2:	0.9
Cos phi:	0.94
Capacitor size - run:	10 µF/400 V
Insulation class (IEC 85):	H
Enclosure class (IEC 60529):	X4D
Motor protec:	CONTACT
Thermal protec:	external
<b>Controls:</b>	
Relay:	without relay
Pos term box:	1.30H
<b>Others:</b>	
Net weight:	17.3 kg
Gross weight:	17.6 kg
Shipping volume:	0.026 m <sup>3</sup>

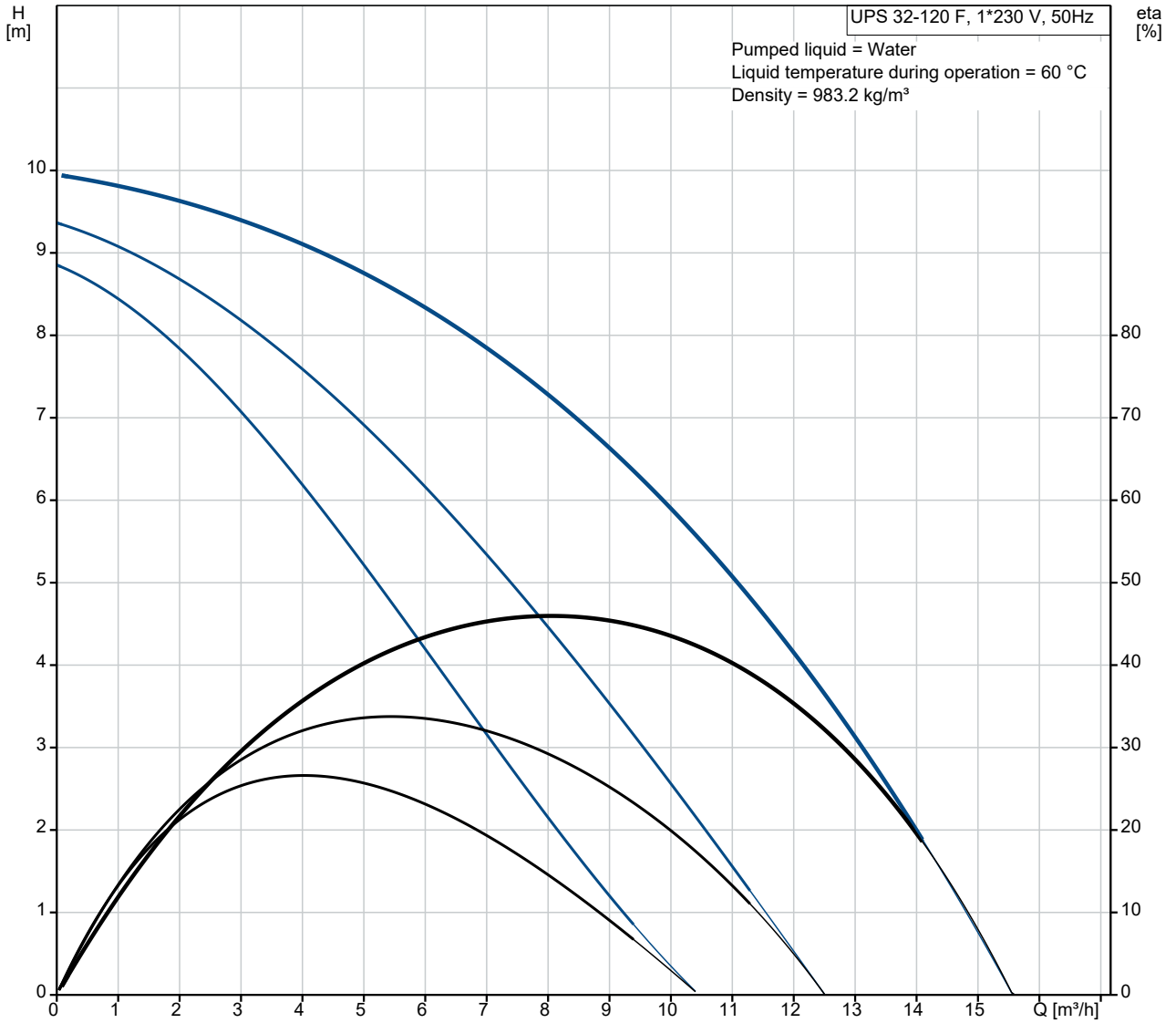
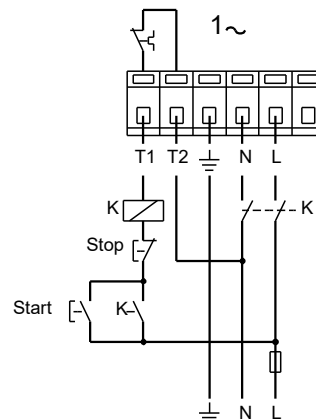
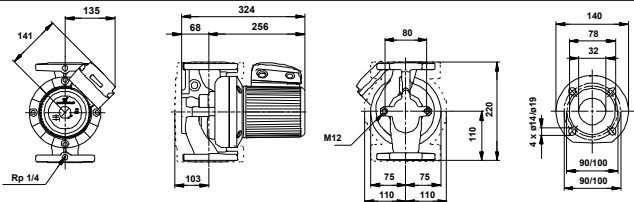
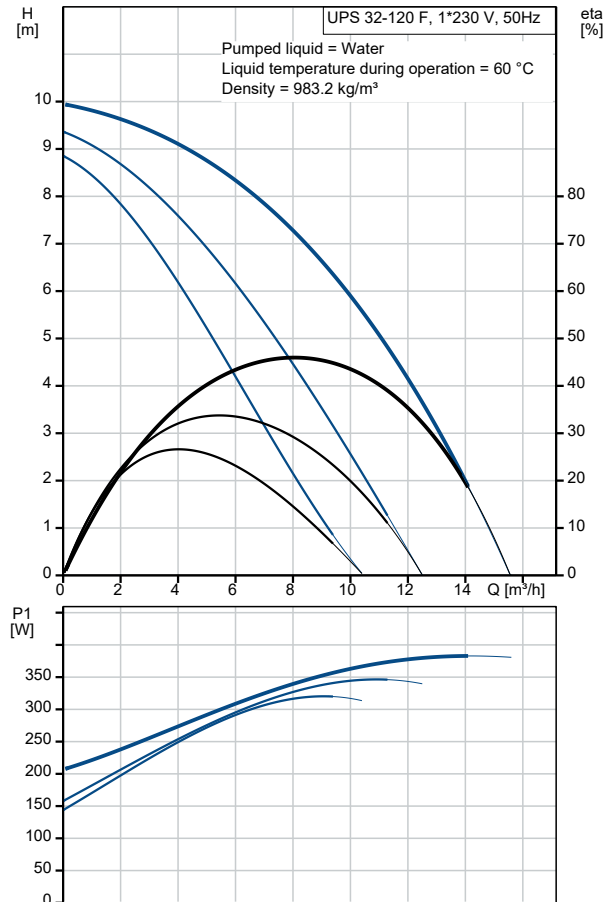

**96401837 UPS 32-120 F 50 Hz**

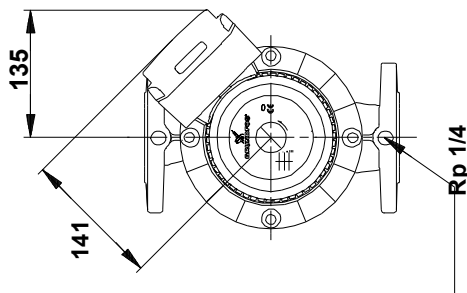
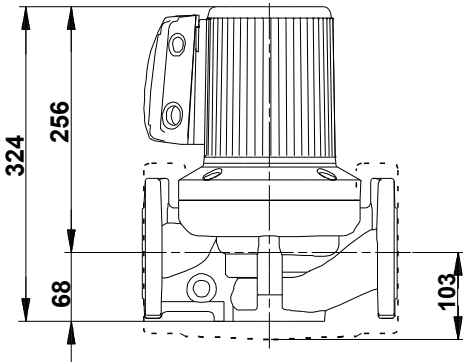
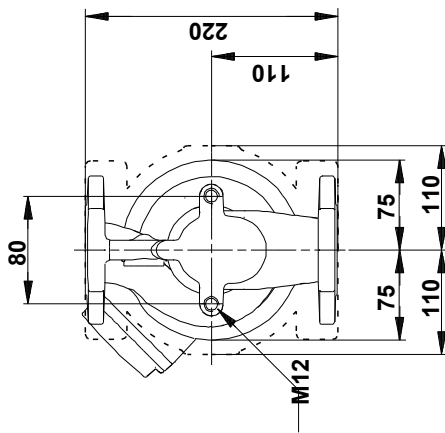
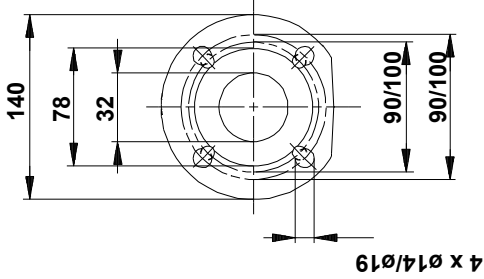

Note! All units are in [mm] unless others are stated.  
 Disclaimer: This simplified dimensional drawing does not show all details.

**96401837 UPS 32-120 F 50 Hz**

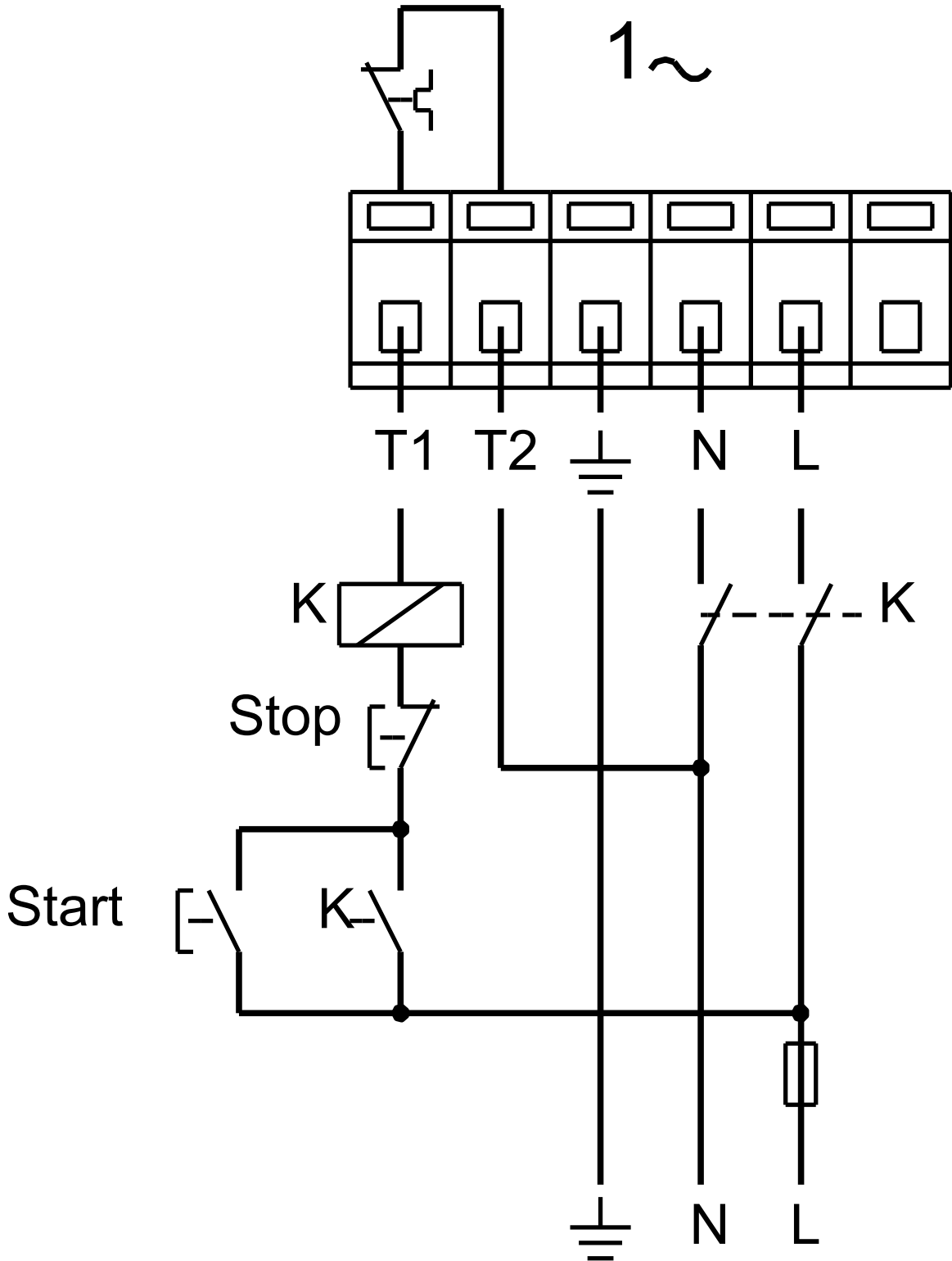

Note! All units are in [mm] unless others are stated.