

97924145 MAGNA1 25-100

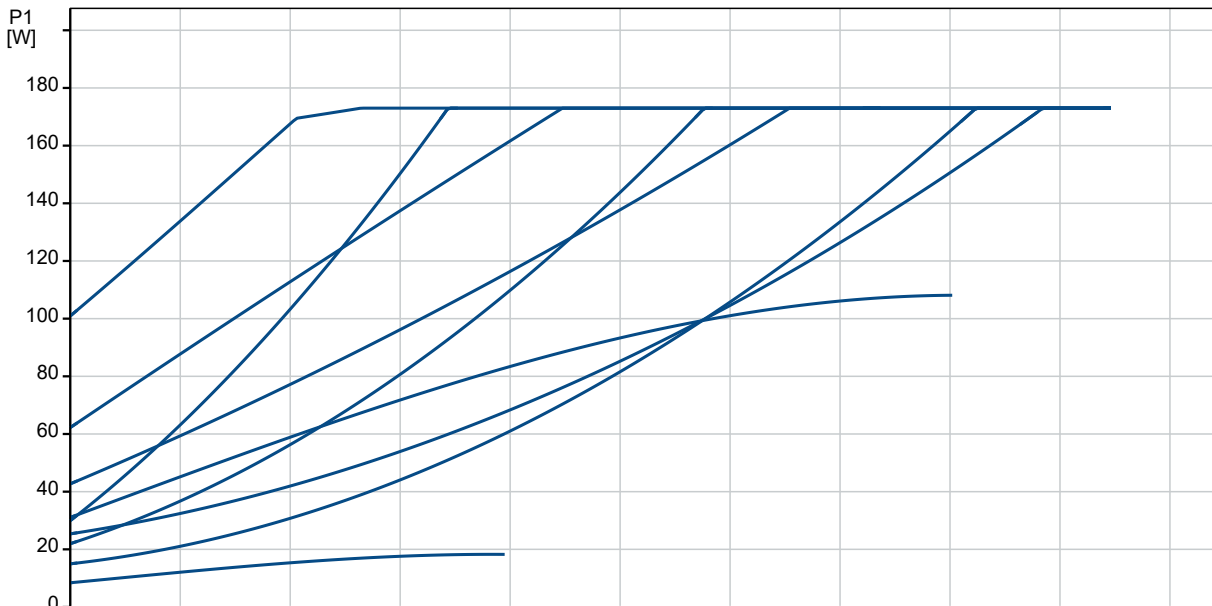

Description	Value
General information:	
Product name:	MAGNA1 25-100
Product No:	97924145
EAN number:	5710626492190
Price:	
Technical:	
Head max:	100 dm
TF class:	110
Approvals on nameplate:	CE, VDE, EAC, CN ROHS
Model:	A
Materials:	
Pump housing:	Cast iron
Pump housing:	EN-GJL-200
Pump housing:	ASTM A48-200B
Impeller:	PES 30%GF
Installation:	
Range of ambient temperature:	0 .. 40 °C
Maximum operating pressure:	10 bar
Pipe connection:	G 1 1/2"
Pressure rating:	PN10
Port-to-port length:	180 mm
Liquid:	
Pumped liquid:	Water
Liquid temperature range:	-10 .. 110 °C
Selected liquid temperature:	60 °C
Density:	983.2 kg/m ³
Electrical data:	
Power input - P1:	9 .. 176 W
Mains frequency:	50 / 60 Hz
Rated voltage:	1 x 230 V
Maximum current consumption:	0.09 .. 1.42 A
Enclosure class (IEC 34-5):	X4D
Insulation class (IEC 85):	F
Others:	
Energy (EEI):	0.22
Net weight:	4.38 kg
Gross weight:	4.78 kg
Shipping volume:	0.012 m ³
Norwegian NRF no.:	9042064

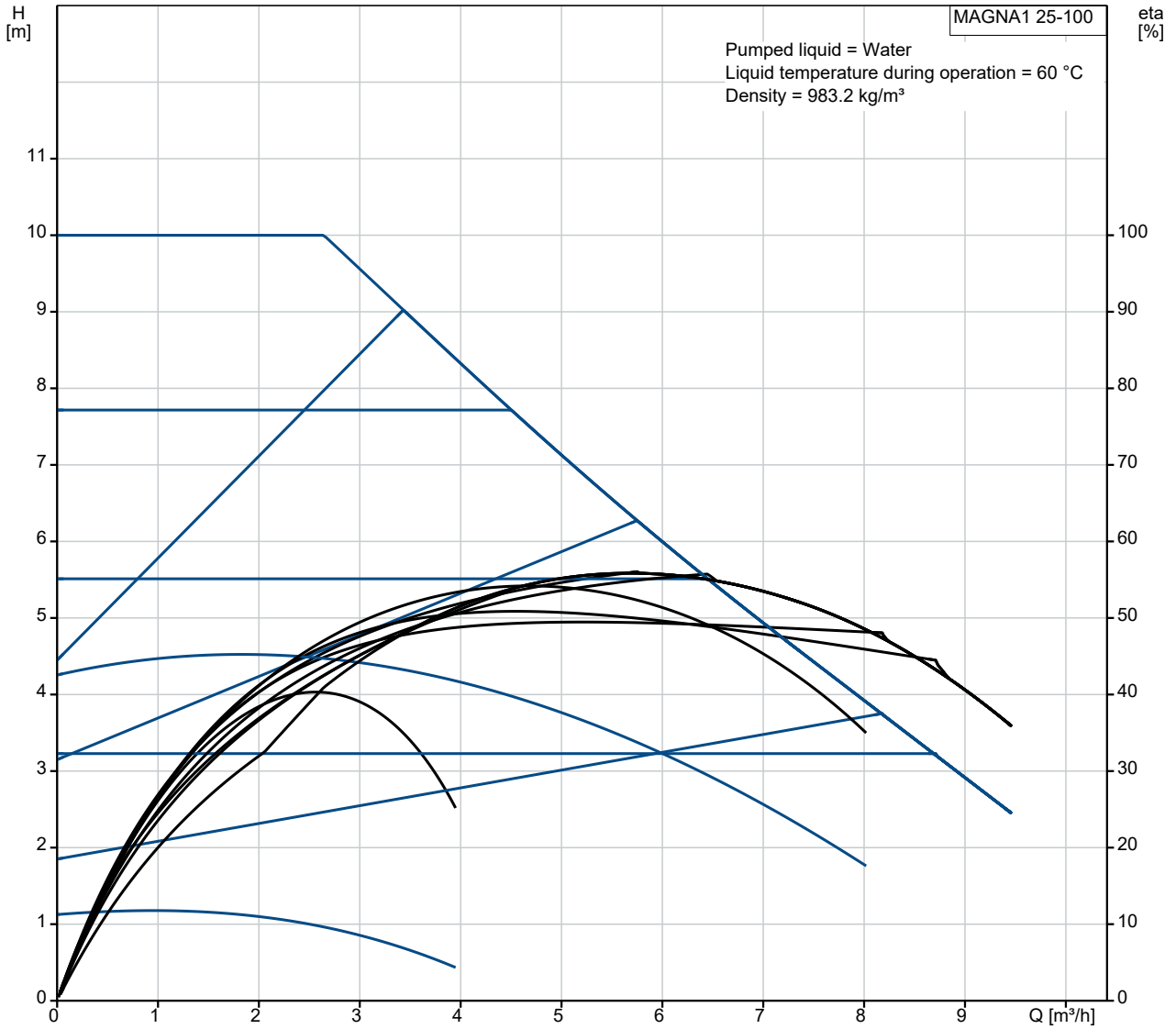
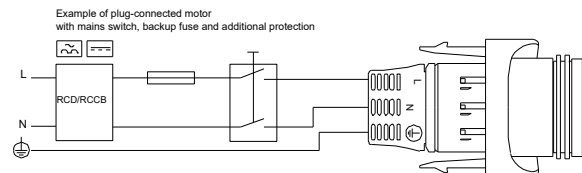
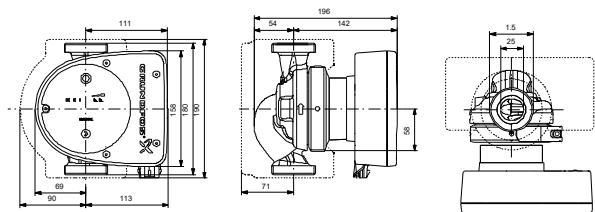
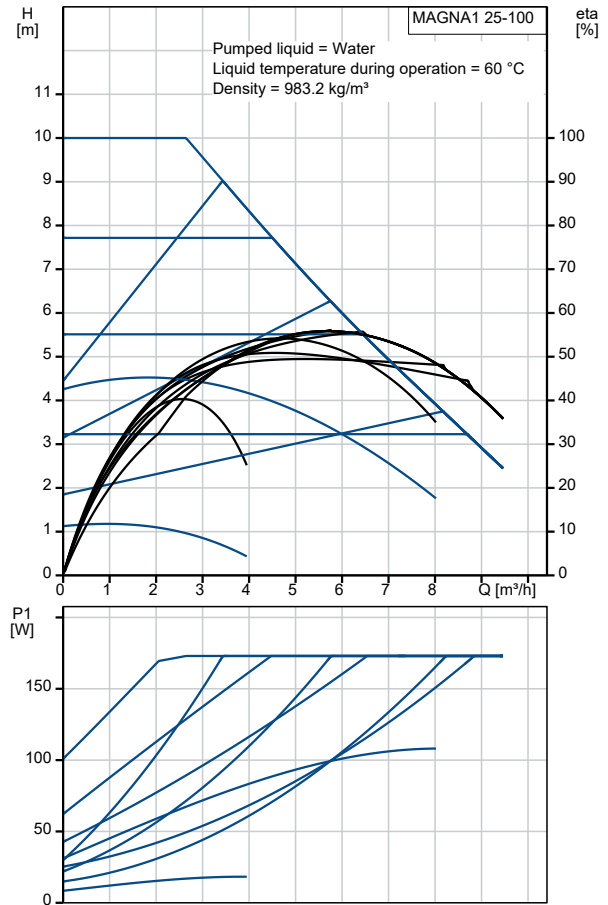

97924145 MAGNA1 25-100

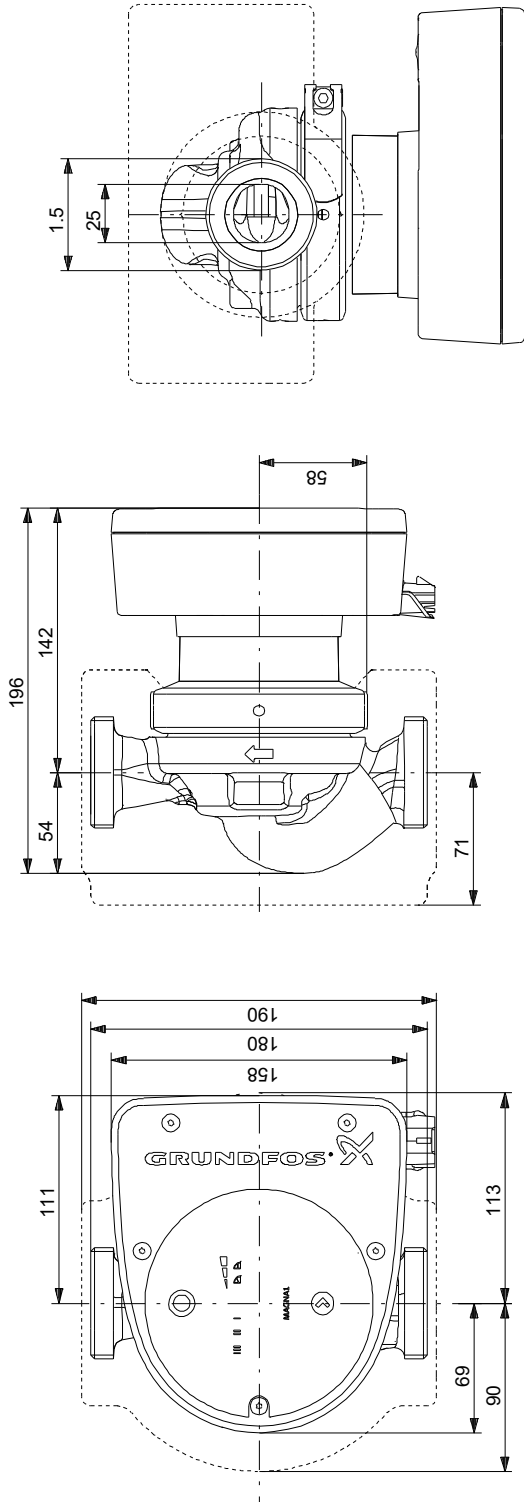

Note! All units are in [mm] unless others are stated.
 Disclaimer: This simplified dimensional drawing does not show all details.

97924145 MAGNA1 25-100

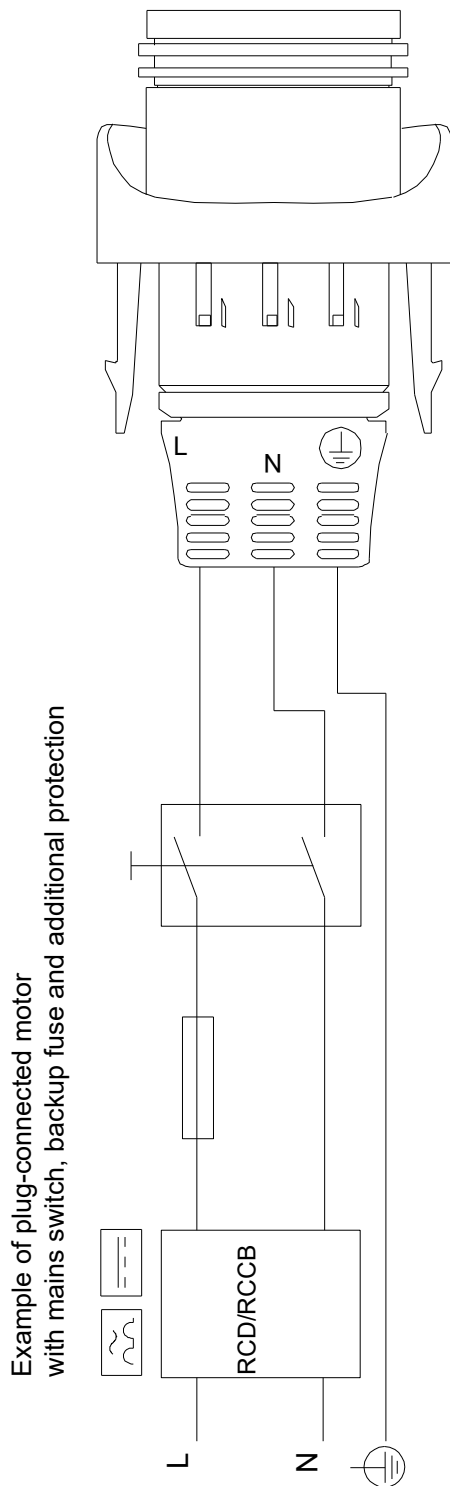

Note! All units are in [mm] unless others are stated.