

96402278 UPS 65-120 F 50 Hz

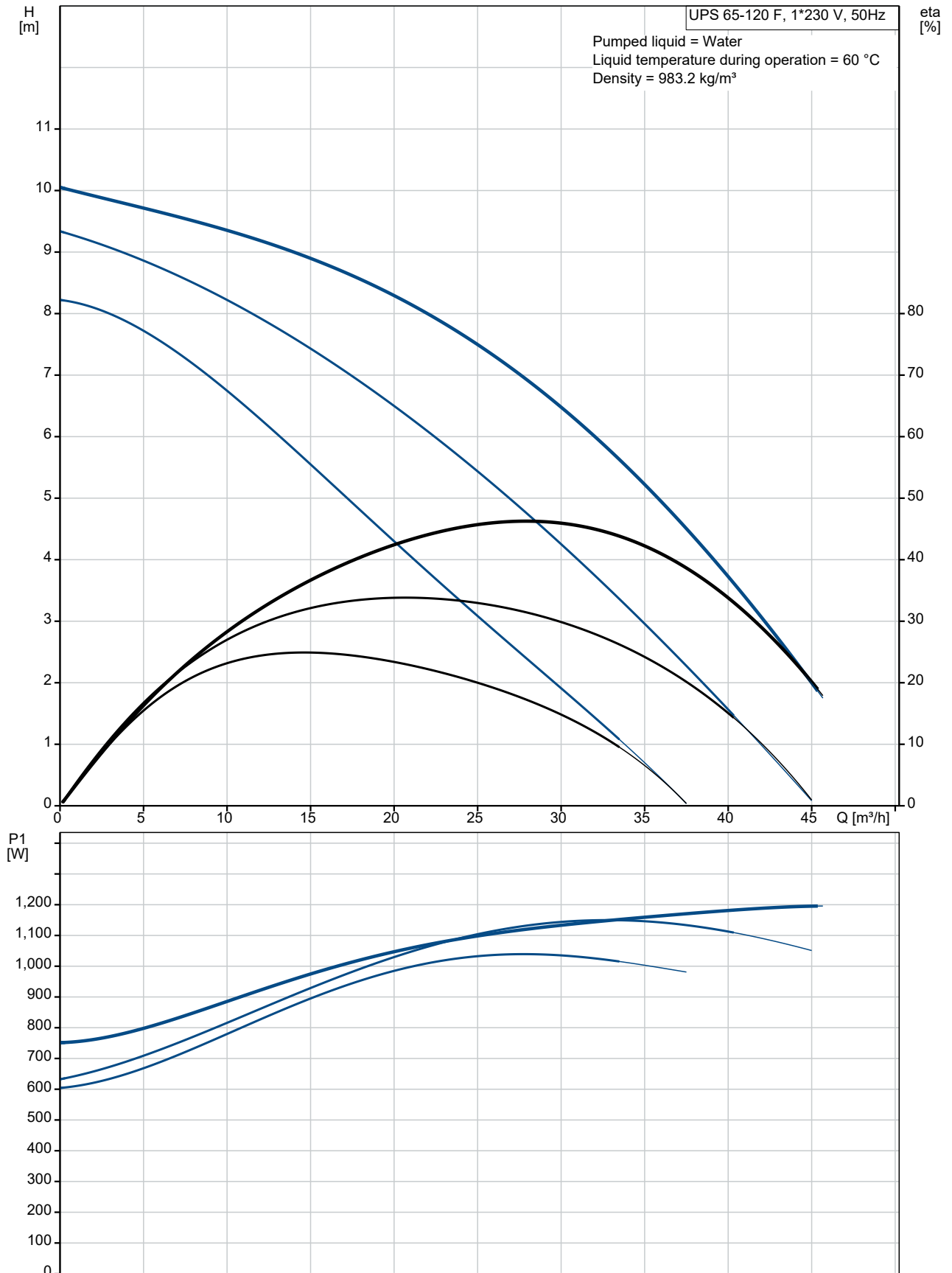

Description	Value
General information:	
Product name:	UPS 65-120 F
Product No:	96402278
EAN number:	5700390664947
Price:	
Technical:	
Speed no:	3
Head max:	120 dm
Approvals on nameplate:	AAA,EAC
Materials:	
Pump housing:	Cast iron
Pump housing:	EN-JL1040
Pump housing:	ASTM 35 B - 40 B
Impeller:	Stainless steel
Impeller:	DIN W.-Nr. 1.4301
Impeller:	AISI 304
Installation:	
Range of ambient temperature:	0 .. 40 °C
Maximum operating pressure:	10 bar
Flange standard:	DIN
Pipe connection:	DN 65
Pressure rating:	PN 6 / PN 10
Port-to-port length:	340 mm
Liquid:	
Pumped liquid:	Water
Liquid temperature range:	-10 .. 120 °C
Selected liquid temperature:	60 °C
Density:	983.2 kg/m ³
Electrical data:	
Power input in speed 1:	1050 W
Power input in speed 2:	1150 W
Max. power input:	1200 W
Mains frequency:	50 Hz
Rated voltage:	1 x 230-240 V
Current in speed 1:	5.1 A
Current in speed 2:	5.6 A
Current in speed 3:	5.5 A
Cos phi in speed 1:	0.9
Cos phi in speed 2:	0.89
Cos phi:	0.95
Capacitor size - run:	30 µF/400 V
Insulation class (IEC 85):	H
Enclosure class (IEC 60529):	X4D
Motor protec:	CONTACT
Thermal protec:	external
Controls:	
Relay:	without relay
Pos term box:	1.30H
Others:	
Net weight:	27.2 kg
Gross weight:	33 kg
Shipping volume:	0.043 m ³

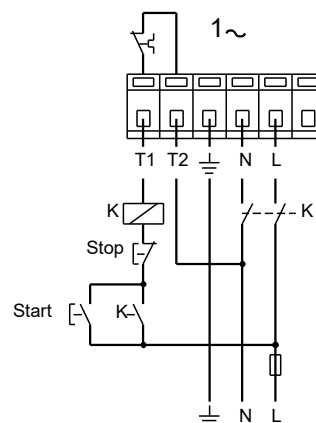
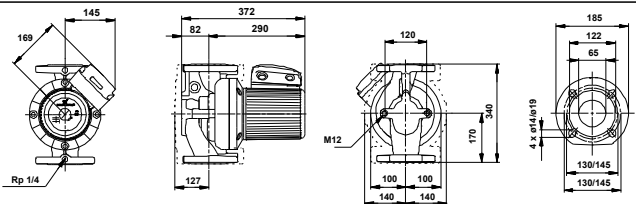
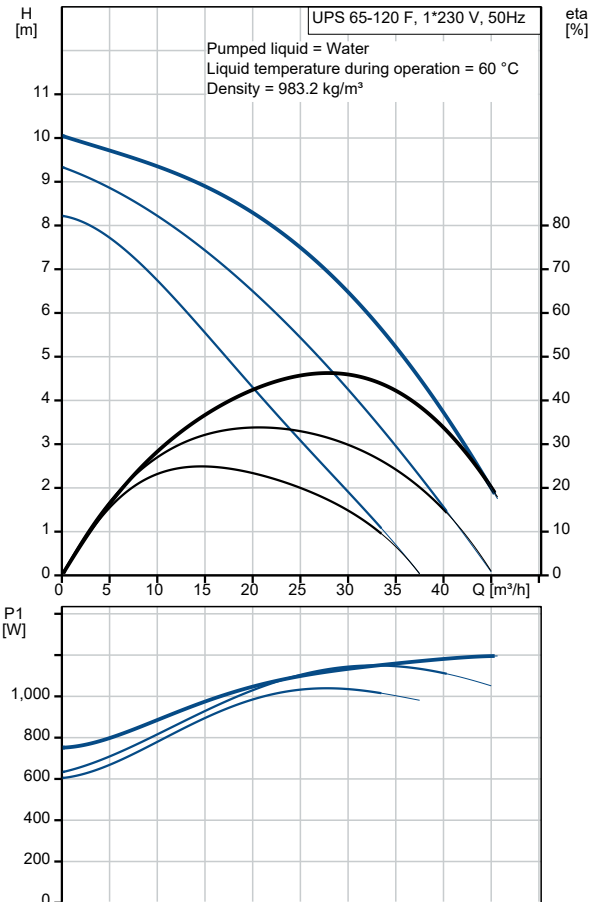

96402278 UPS 65-120 F 50 Hz

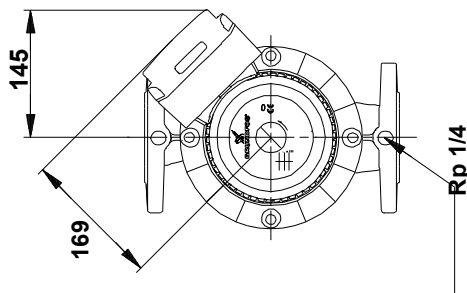
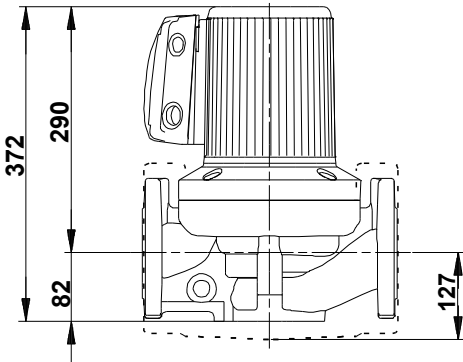
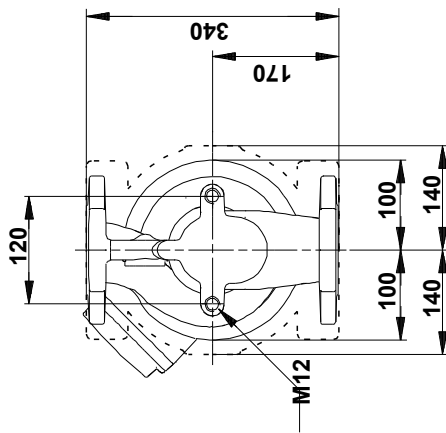
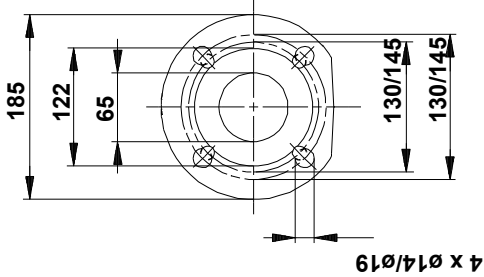

Note! All units are in [mm] unless others are stated.
 Disclaimer: This simplified dimensional drawing does not show all details.

96402278 UPS 65-120 F 50 Hz

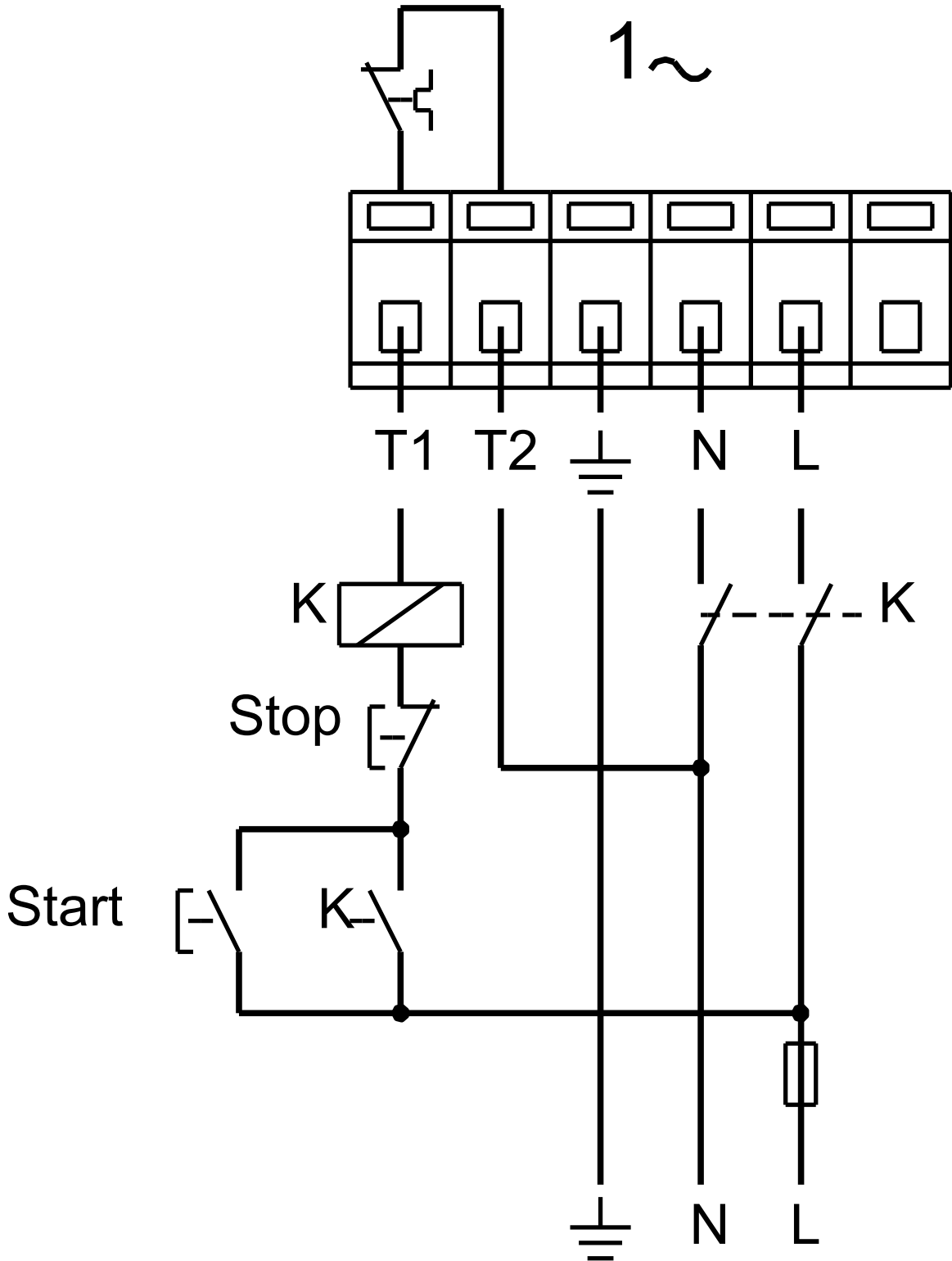

Note! All units are in [mm] unless others are stated.