

## On request UPS 32-60 180 50 Hz

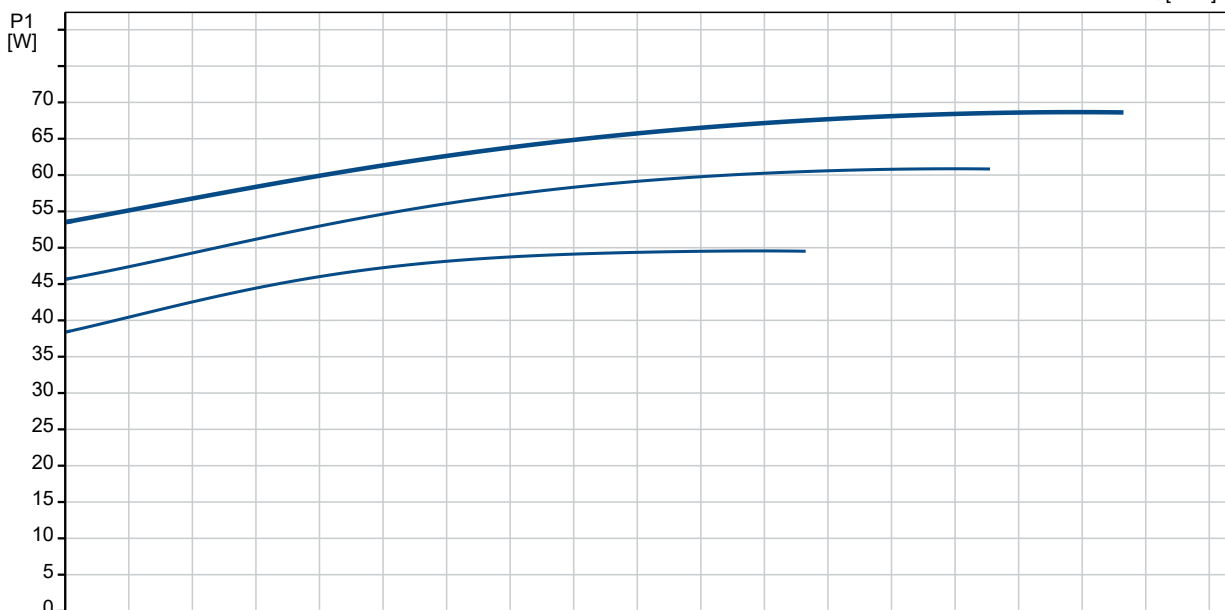

Description	Value
<b>General information:</b>	
Product name:	UPS 32-60 180
Product No:	On request
EAN number:	On request
Price:	
<b>Technical:</b>	
Speed no:	3
Head max:	60 dm
TF class:	110
Approvals on nameplate:	EAC
<b>Materials:</b>	
Pump housing:	Cast iron
Pump housing:	EN-JL1030
Pump housing:	ASTM 30 B
Impeller:	Composite, PES/PP
<b>Installation:</b>	
Amb. max at 80 dgr C liquid:	40 °C
Maximum operating pressure:	10 bar
Pipe connection:	G 2
Pressure rating:	PN 10
Port-to-port length:	180 mm
<b>Liquid:</b>	
Pumped liquid:	Water
Liquid temperature range:	2 .. 110 °C
Selected liquid temperature:	60 °C
Density:	983.2 kg/m <sup>3</sup>
<b>Electrical data:</b>	
Power input in speed 1:	50 W
Power input in speed 2:	55 W
Max. power input:	60 W
Mains frequency:	50 Hz
Rated voltage:	1 x 230 V
Current in speed 1:	0.21 A
Current in speed 2:	0.25 A
Current in speed 3:	0.28 A
Capacitor size - run:	2.5 µF
Enclosure class (IEC 34-5):	IP44
Insulation class (IEC 85):	F
Motor protec:	NONE
Thermal protec:	Impedance protected
<b>Controls:</b>	
Pos term box:	9H
<b>Others:</b>	
Net weight:	2.6 kg
Gross weight:	2.8 kg
Shipping volume:	0.004 m <sup>3</sup>
Country code:	RU

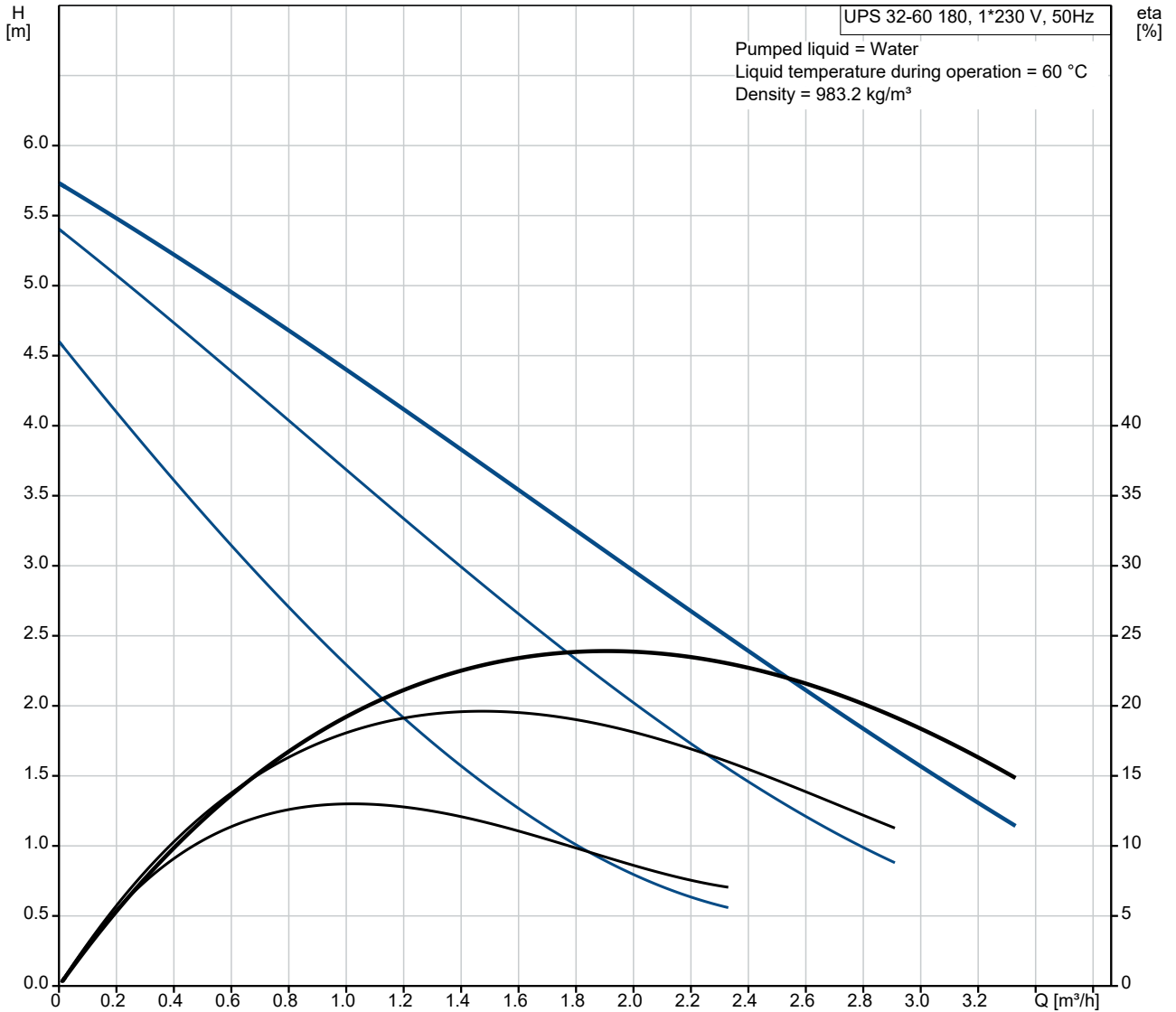
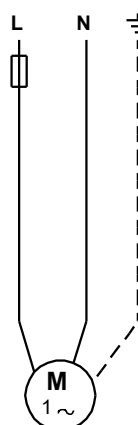
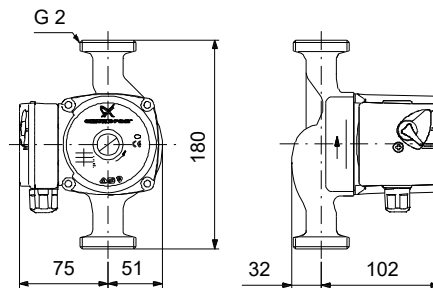
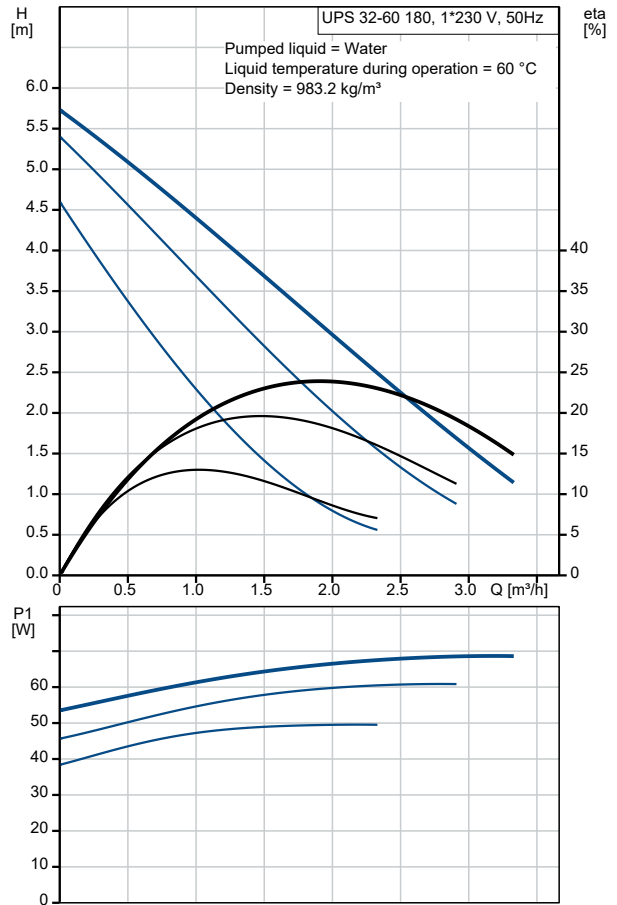

## On request UPS 32-60 180 50 Hz

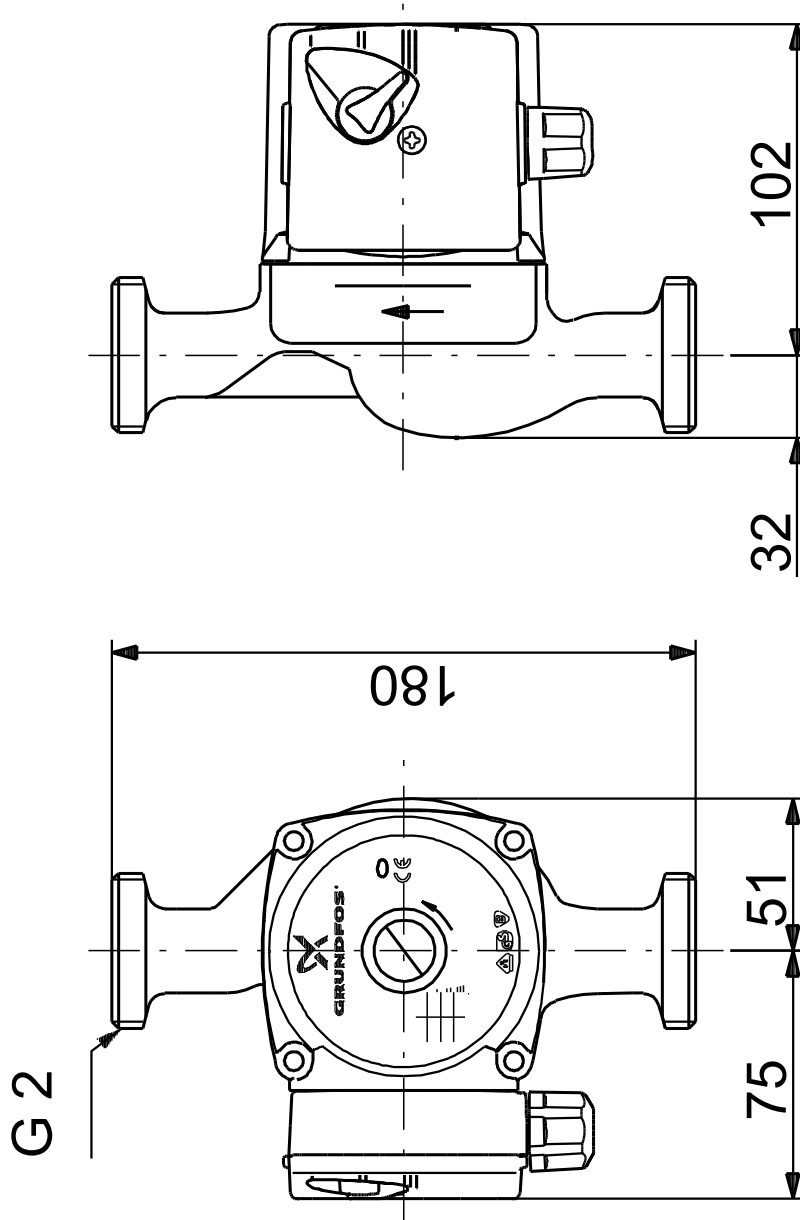

Note! All units are in [mm] unless others are stated.  
Disclaimer: This simplified dimensional drawing does not show all details.

### On request UPS 32-60 180 50 Hz

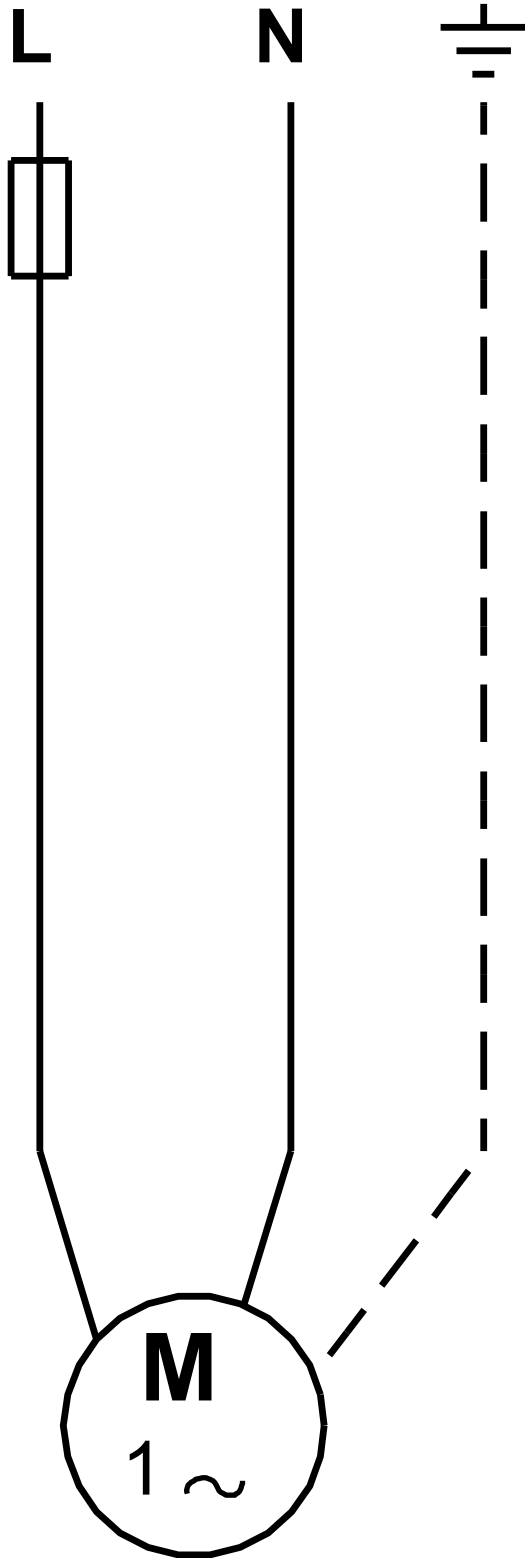

Note! All units are in [mm] unless others are stated.